



**Specifications** (measured @ Ta= 25°C, nom. Vin, full load and after warm-up unless otherwise stated)

**BASIC CHARACTERISTICS**

Parameter	Condition	Min.	Typ.	Max.
Internal Input Filter				Pi type
Input Voltage Range <sup>(4, 5)</sup>	nom. Vin= 230VAC	85VAC 120VDC	230VAC	264VAC 370VDC
Input Current	115VAC 230VAC			450mA 400mA
Inrush Current	cold start at +25°C	115VAC 230VAC		20A 40A
No Load Power Consumption	230VAC		40mW	
ErP Lot 6 Standby Mode Conformity (Output Load Capability)	0.5W Input Power = 1.0W 2.0W			0.3W 0.7W 1.6W
Input Frequency Range	AC Input	47Hz		63Hz
Minimum Load <sup>(7)</sup>	single dual (required for regulation on both outputs)	0%	10%	
Power Factor	115VAC 230VAC	0.6 0.5		
Start-up Time			150ms	
Rise Time			40ms	
Hold-up Time	115VAC 230VAC		15ms 90ms	
Internal Operating Frequency				100kHz
Output Ripple and Noise <sup>(6)</sup>	20MHz BW		100mVp-p	

**Notes:**

Note4: The products were submitted for safety files at AC-Input operation

Note5: Refer to "Line Derating"

Note6: Measurements are made with a 1.0µF MLCC across output (low ESR)

**Efficiency vs. Load**

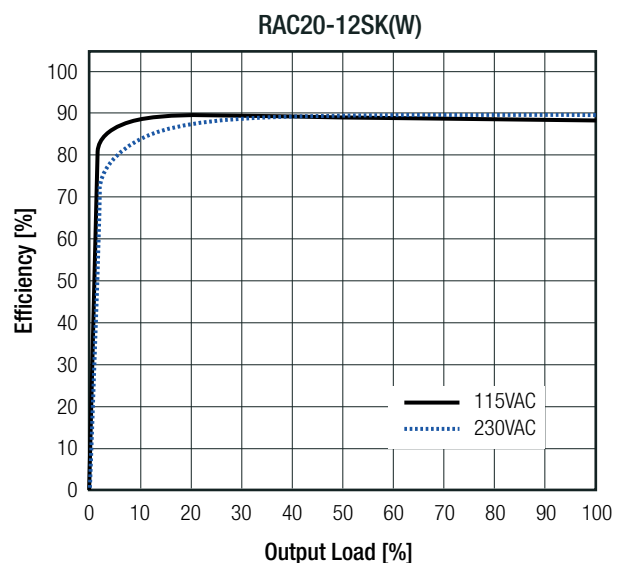
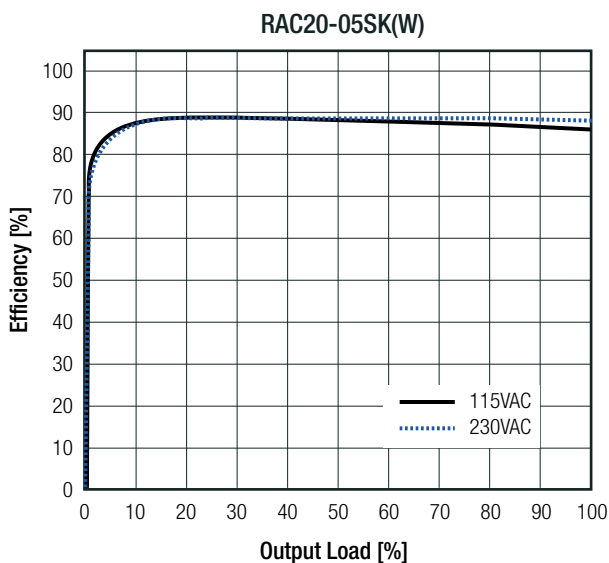

continued on next page

**Specifications** (measured @ Ta= 25°C, nom. Vin, full load and after warm-up unless otherwise stated)

**Efficiency vs. Load**

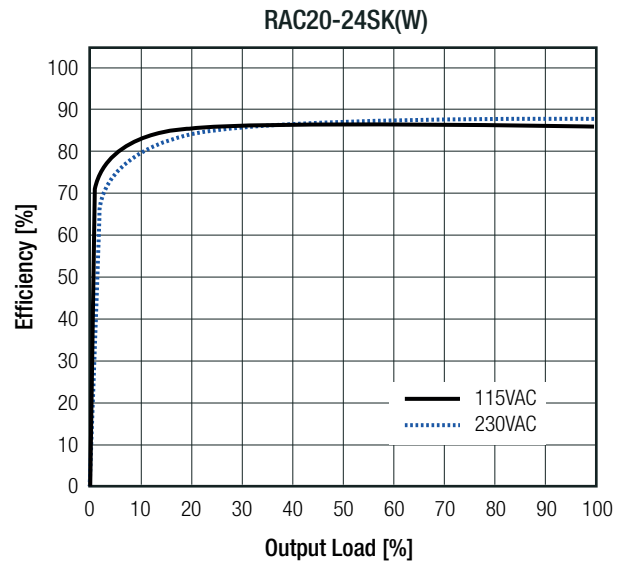
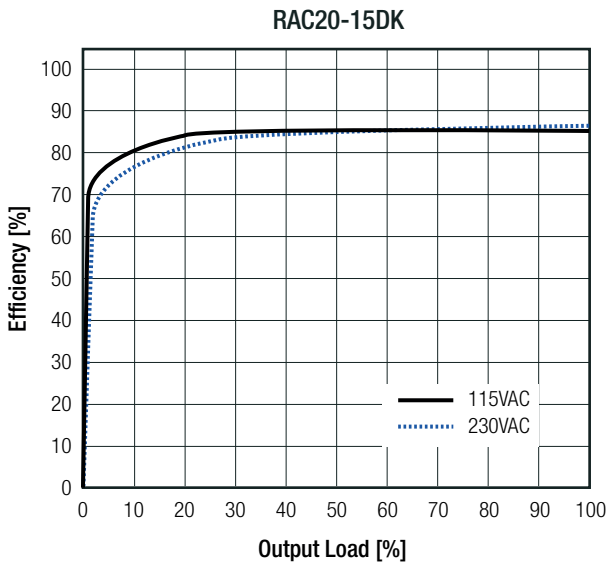

**REGULATIONS**

Parameter	Condition	Value
Output Accuracy		±2.0% typ.
Line Regulation	low line to high line	±0.5% typ.
Load Regulation <sup>(7)</sup>	10% to 100% load	±2.0% typ.
Cross Regulation	dual output only	±10.0% typ.
Transient Response	25% load step change recovery time	4.0% max. 500µs typ.

**Notes:**

Note7: Operation below 10% load will not harm the converter, but specifications may not be met

**Deviation vs. Load**

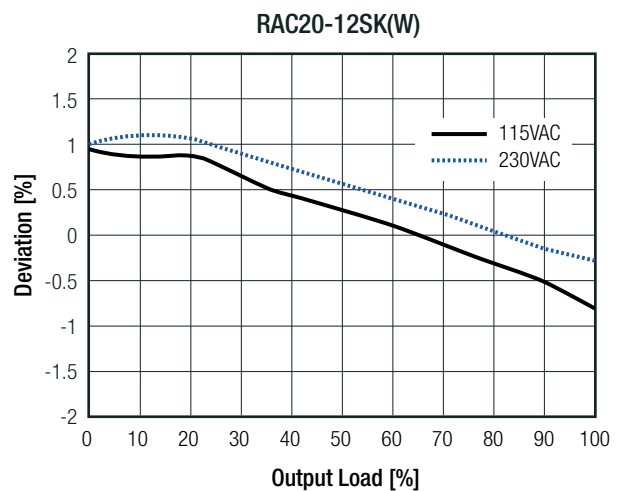
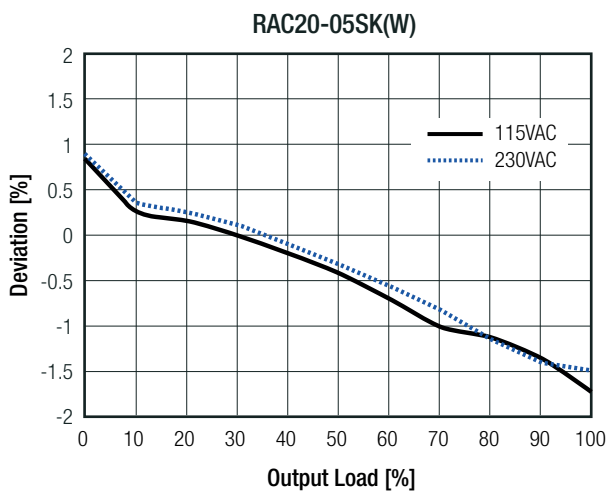

continued on next page

**Specifications** (measured @ Ta= 25°C, nom. Vin, full load and after warm-up unless otherwise stated)

**Deviation vs. Load**

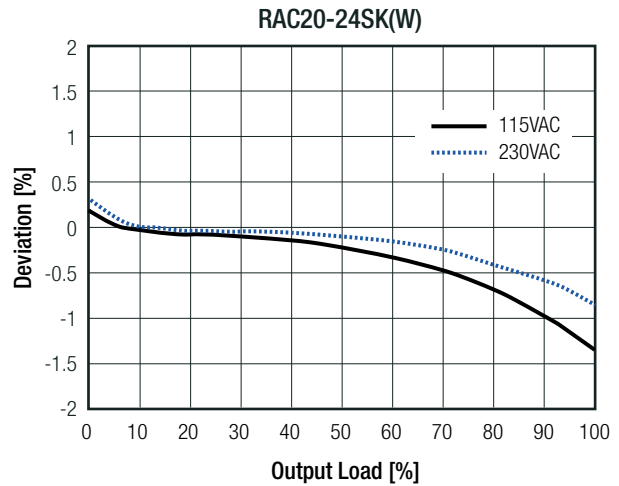
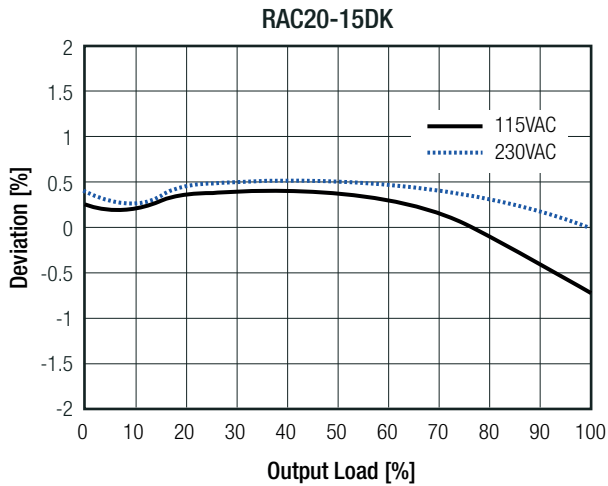

**PROTECTIONS**

Parameter	Type	Value
Input Fuse <sup>(8)</sup>	internal	T3.15A, slow blow type
Short Circuit Protection (SCP)	below 100mΩ	hiccup, auto recovery
Over Voltage Protection (OVP)		150% - 195%, latch off mode
Over Current Protection (OCP)		110% - 130%, hiccup mode
Over Voltage Category		OVCII
Class of Equipment		Class II
Isolation Voltage <sup>(9)</sup>	I/P to O/P	tested for 1 minute
Isolation Resistance		V <sub>iso</sub> = 500VDC
Isolation Capacitance		100pF max.
Insulation Grade		reinforced
Leakage Current		0.25mA max.

**Notes:**

- Note8: Refer to local safety regulations if input over-current protection is also required  
 Note9: For repeat Hi-Pot testing, reduce the time and/or the test voltage

**ENVIRONMENTAL**

Parameter	Condition	Value
Operating Temperature Range	@ natural convection 0.1m/s	full load: -40°C to +55°C
		refer to derating graph: -40°C to +85°C
Maximum Case Temperature		+95°C
Temperature Coefficient		0.05%/K
Operating Altitude		3000m
Operating Humidity	non-condensing	20% - 90% RH max.
IP Rating		IP20
Pollution Degree		PD2
Vibration	according to MIL-STD-202G	10-500Hz, 2G 10min./1cycle, period 60min. along x,y,z axes
Design Lifetime	+25°C	130 x 10 <sup>3</sup> hours
	+55°C	16 x 10 <sup>3</sup> hours
MTBF	according to MIL-HDBK-217F, G.B.	+25°C
		+40°C
		>1196 x 10 <sup>3</sup> hours
		>955 x 10 <sup>3</sup> hours

continued on next page

**Specifications** (measured @ Ta= 25°C, nom. Vin, full load and after warm-up unless otherwise stated)

**Derating Graph**

(@ Chamber and natural convection 0.1 m/s)

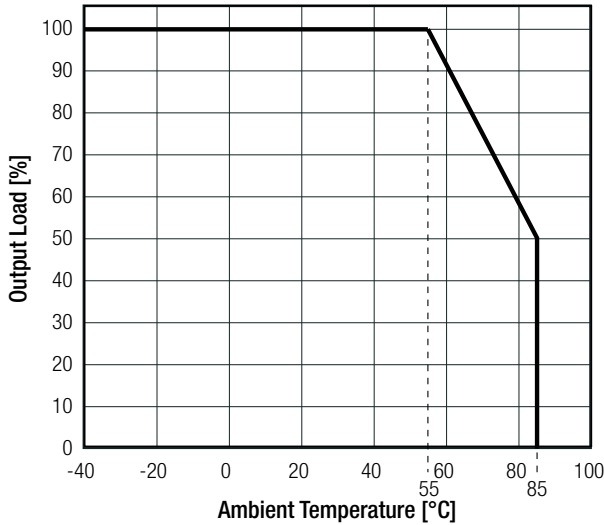

**Line Derating**

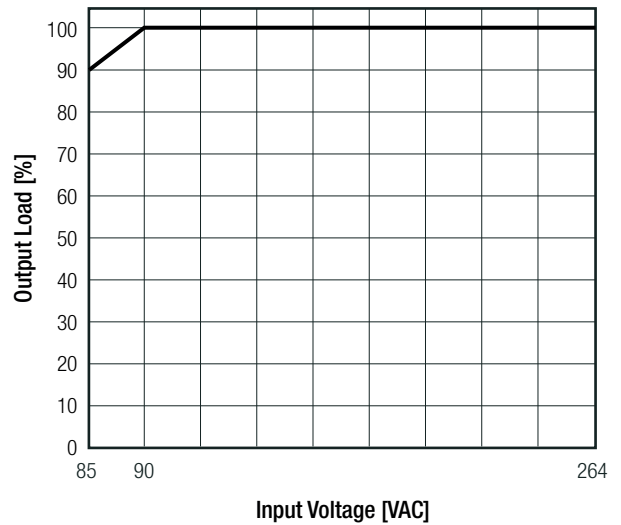

**SAFETY AND CERTIFICATIONS**

Certificate Type (Safety)	Report / File Number	Standard
Audio/Video, information and communication technology equipment - Safety requirements	E224736	UL62368-1, 2nd Edition, 2014 CAN/CSA C22.2 Nr. 62368-1-14, 2nd Ed. 2014
Audio/Video, information and communication technology equipment - Safety requirements (CB Scheme)	E491408-A6008-CB-1	IEC62368-1:2014 2nd Edition
Audio/Video, information and communication technology equipment - Safety requirements (LVD)		EN62368-1:2014 + A11:2017
Household and similar electrical appliances – Safety – Part 1: General requirements	LCS180508046AS	IEC60335-1:2010 + AMD2:2016 + COR1:2016 EN60335-1:2012 + A11:2014 + A13:2017
Safety of power transformers, power supplies, reactors and similar products for supply voltages up to 1100 V (CB Scheme)	50198090 001	IEC61558-1:2005 2nd Edition + A1:2009
Safety of power transformers, power supplies, reactors and similar products for supply voltages up to 1100 V		EN61558-1:2005 + A1:2009
Safety of power transformers, power supplies, reactors and similar products for supply voltages up to 1100 V Part 2: Particular requirements (CB Scheme)	50198090 001	IEC61558-2-16:2009 1st Edition + A1:2013
Safety of power transformers, power supplies, reactors and similar products for supply voltages up to 1100 V Part 2: Particular requirements		EN61558-2-16:2009 + A1:2013
EAC	RU-AT.03.67361	TP TC 004/2011
RoHS2+		RoHS-2011/65/EU + AM-2015/863

EMC Compliance	Condition	Standard / Criterion
Low voltage power supplies, d.c. output Part 3: Electromagnetic compatibility (EMC)		IEC/EN61204-3:2018, Class B
Electromagnetic compatibility of multimedia equipment - Emission requirements	without external filter	EN55032:2015, Class B
Electromagnetic compatibility of household appliances, electric tools and similar apparatus - Emission Requirements		EN55014-1:2006 + A2:2011
Information technology equipment - Immunity characters - Limits and methods of measurement		EN55024:2010 + A1:2015
Electromagnetic compatibility of household appliances, electric tools and similar apparatus - Immunity Requirements		EN55014-2:2015
ESD Electrostatic discharge immunity test	Air ±8kV, Contact ±4kV	EN61000-4-2:2009, Criteria B
Radiated, radio-frequency, electromagnetic field immunity test	80MHz - 6GHz: 10V/m 1.4GHz - 2GHz: 3V/m 2.0GHz - 2.7GHz: 1V/m	EN61000-4-3:2006 + A1:2008, Criteria A

continued on next page

**Specifications** (measured @ Ta= 25°C, nom. Vin, full load and after warm-up unless otherwise stated)

EMC Compliance	Condition	Standard / Criterion
Fast Transient and Burst Immunity	AC Port: ±2.0kV DC Port: ±2.0kV	EN61000-4-4:2012, Criteria B
Surge Immunity	AC Port: L-N ±1.0kV DC Port: ±0.5kV	EN61000-4-5:2014 + A1:2017, Criteria B
Immunity to conducted disturbances, induced by radio-frequency fields	AC Port: 10V DC Port: 10V	EN61000-4-6:2014, Criteria A
Power Magnetic Field Immunity	50Hz, 30A/m	EN61000-4-8:2010, Criteria A
Voltage Dips and Interruptions	Voltage Dips 20% Voltage Dips 30% Voltage Dips 60% Voltage Dips 100% Voltage Interruptions > 95%	EN61000-4-11:2004 + A1:2017, Criteria C EN61000-4-11:2004 + A1:2017, Criteria C EN61000-4-11:2004 + A1:2017, Criteria C EN61000-4-11:2004 + A1:2017, Criteria B EN61000-4-11:2004 + A1:2017, Criteria C
Limits of Voltage Fluctuations & Flicker		EN61000-3-3:2013
Limitations on the amount of electromagnetic interference allowed from digital and electronic devices		FCC 47 CFR Part 15 Subpart B, Class B
American National Standard for Methods of Measurement of Radio-Noise Emissions from Low-Voltage Electrical and Electronic Equipment in the Range of 9 kHz to 40 GHz		ANSI C63.4-2014, Class B
<b>Notes:</b> Note9: If output is connected to GND, please contact RECOM tech support for advice		

**DIMENSION AND PHYSICAL CHARACTERISTICS**

Parameter	Type	Value
Material	case	black plastic, (UL94V-0)
	potting	silicone, (UL94V-0)
	PCB	FR4, (UL94V-0)
	baseplate	black plastic, (UL94V-0)
Dimension (LxWxH)		52.5 x 27.4 x 23.0mm
Weight	pin	60g typ.
	wired	65g typ.

**Dimension Drawing (mm)**

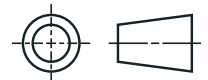
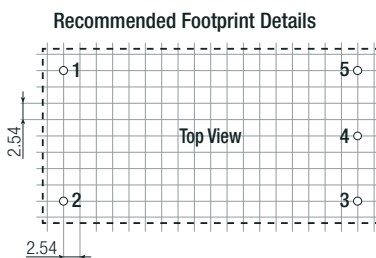
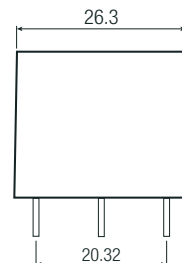
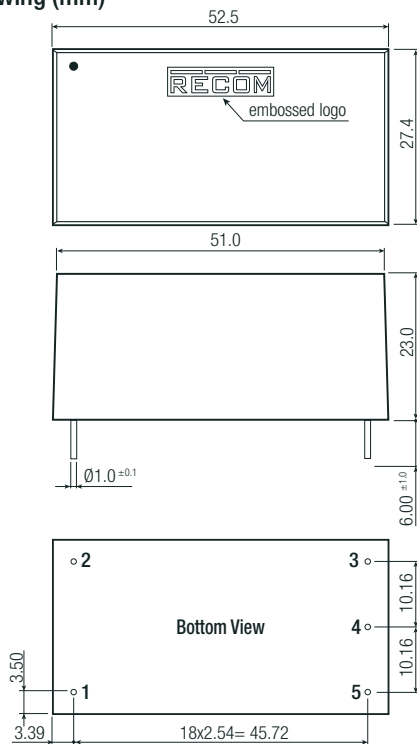

**Pinning information**

Pin #	Single	Dual
1	VAC in (N)	VAC in (N)
2	VAC in (L)	VAC in (L)
3	no pin	-Vout
4	-Vout	Com
5	+Vout	+Vout

Tolerance: xx.x= ±0.5mm  
xx.xx= ±0.25mm

continued on next page

**Specifications** (measured @ Ta= 25°C, nom. Vin, full load and after warm-up unless otherwise stated)

**Dimension Drawing Single Wired (mm)**

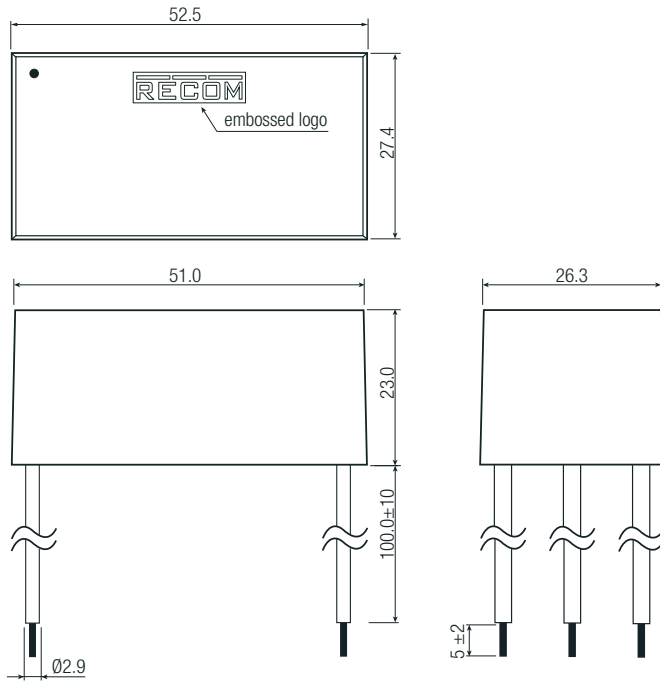
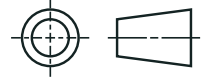

**Wired information**

#	Function	Wire color	Type	AWG
1	VAC in (N)	blue	UL-1015	18
2	VAC in (L)	brown	UL-1015	18
4	-Vout	black	UL-1015	18
5	+Vout	red	UL-1015	18

Tolerance: xx.x= ±0.5mm  
xx.xx= ±0.25mm

**PACKAGING INFORMATION**

Parameter	Type		Value
	pin wired	tube tray	
Packaging Dimension (LxWxH)			490.0 x 56.0 x 40.0mm
			488.0 x 202.0 x 47.0mm
Packaging Quantity		tube tray	15pcs
		tray	20pcs
Storage Temperature Range			-40°C to +85°C
Storage Humidity		non-condensing	20% to 90% RH max.

The product information and specifications may be subject to changes even without prior written notice. The product has been designed for various applications; its suitability lies in the responsibility of each customer. The products are not authorized for use in safety-critical applications without RECOM's explicit written consent. A safety-critical application is an application where a failure may reasonably be expected to endanger or cause loss of life, inflict bodily harm or damage property. The applicant shall indemnify and hold harmless RECOM, its affiliated companies and its representatives against any damage claims in connection with the unauthorized use of RECOM products in such safety-critical applications.